

# Actuator

14-  
134.0252

Distribution by  
Farnell



<https://farnell.eao.com/component/14-134.0252...>

Your product:

---



# 14-134.0252 Actuator

*Loading ...*

## FRONT

**Front form:** Round

## MOUNTING

**Mounting type:** Panel mounting

## OPERATING-/INDICATION PART

**Lens illumination:** Illuminated

## ELECTRICAL CHARACTERISTICS

**Switching voltage and switching current:**  
250 VAC, 5 A (ohmic)  
250 VAC, 3 A (Soldering terminal)  
250 VAC, 2 A (inductive,  $\cos(\phi) = 0.7$ )  
220 VDC, 0.1 A (inductive, L:R = 30 ms)  
110 VDC, 0.2 A (inductive, L:R = 30 ms)  
60 VDC, 0.7 A (inductive, L:R = 30 ms)  
24 VDC, 2 A (inductive, L:R = 30 ms)

**Contacts:** 4 NC / 4 NO

**Rated Operational Voltage  $U_e$ :** 250 VAC/DC according to EN IEC 61058-1

**Switching rating:** 250 V @ 3 A

**Electrical lifetime:** 50 000 cycles of operation

**Electric strength:** 3000 VAC, 50 Hz, 1 min. between all terminals and earth, according to EN/IEC 61058-1

**Protection class:** II

**Standards:** According to EN/IEC 61058-1

**Thermal current  $I_{th}$ :** The maximum current in continuous operation and at ambient temperature not exceeding the quoted maximum values.  
3 A

## MECHANICAL CHARACTERISTICS

<b>Terminal:</b>	Soldering terminal
<b>Contact material:</b>	Gold
<b>Switching action:</b>	Momentary
<b>Switching system:</b>	Snap-action switching element
<b>Switching system:</b>	Self-cleaning, double-break snap action switching system, 1 normally closed and 1 normally open contact per element.
<b>Mechanical lifetime:</b>	2 Mil. cycles of operation
<b>Operating force:</b>	3 N ... 6 N, depending on the number of switching elements
<b>Operating Travel:</b>	3 mm
<b>Tightening torque:</b>	Fixing nut max. 0.25 Nm
<b>Weight:</b>	0.019 kg

## AMBIENT CONDITION

<b>IP front protection:</b>	IP67, according to DIN EN 60529
<b>Operating temperature:</b>	- 25 °C ... + 55 °C, mounted as a block, make sure the heat can escape freely
<b>Storage temperature:</b>	- 40 °C ... + 85 °C
<b>Shock resistance:</b>	Max. 150 m / s <sup>2</sup> , pulse width 11 ms, 3-axis, (semi-sinusoidal as per EN IEC 60068-2-27)
<b>Vibration resistance:</b>	Max. 100 m / s <sup>2</sup> from 10 Hz ... 500 Hz, (sinusoidal EN IEC 60068-2-6)
<b>Climate resistance:</b>	Standard condition, as per DIN EN 60068-2-78 Standard cyclic, as per DIN IEC 60068-2-30

## CERTIFICATE

<b>Approbations:</b>	CB (IEC 61058-1), CQC, CSA, DNV, EAC, ENEC (EN 61058-1), UL, VDE
<b>Conformities:</b>	CE, UKCA, 2011 / 65 / EC (RoHS), 2014 / 35 / EU (LVD)
<b>REACH:</b>	REACH compliant
<b>RoHS:</b>	RoHS compliant

## OTHER

<b>Short Description:</b>	Actuator, Illuminated, Round, 4 NC / 4 NO, Momentary, Soldering terminal, IP67, according to DIN EN 60529
<b>Housing colour:</b>	Black

**max. number of switching elements:**

4

**Wiring diagrams:**

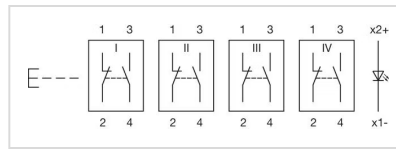

**Mounting cut-outs:**

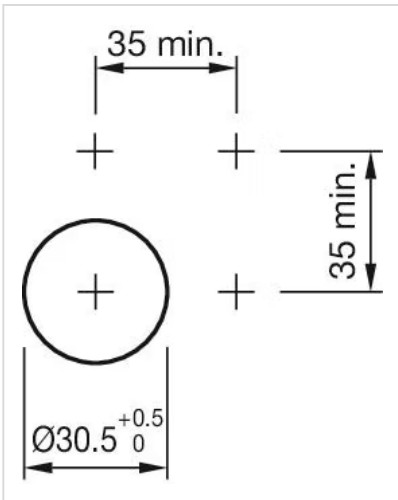



Dimension drawings:

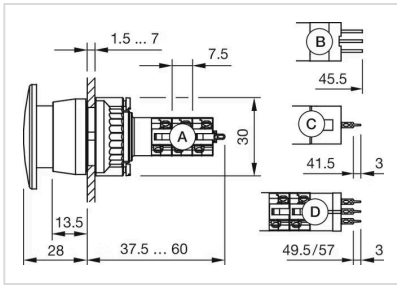

A = Solder terminal  
 B = Plug-in terminal 2.8 x 0.5 mm  
 C = Universal terminal 2.0 mm x 0.5 mm  
 D = Universal-Solder terminal

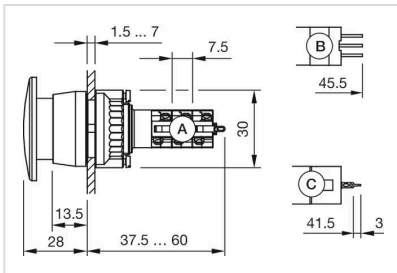

A = Solder terminal  
 B = Plug-in terminal 2.8 x 0.5 mm  
 C = Universal terminal 2.0 mm x 0.5 mm

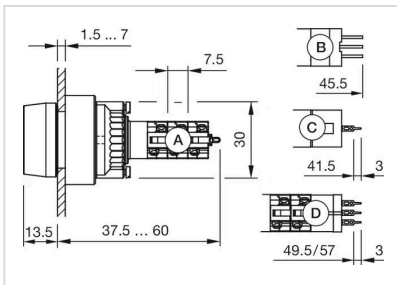

A = Solder terminal  
 B = Plug-in terminal 2.8 x 0.5 mm  
 C = Universal terminal 2.0 mm x 0.5 mm  
 D = Universal-Solder terminal

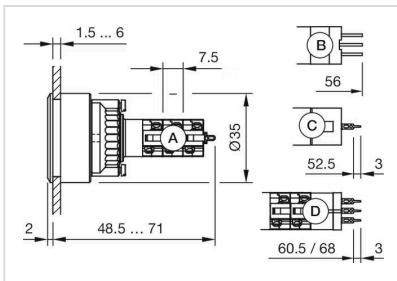

A = Solder terminal  
 B = Plug-in terminal 2.8 x 0.5 mm  
 C = Universal terminal 2.0 mm x 0.5 mm  
 Universal-Solder terminal

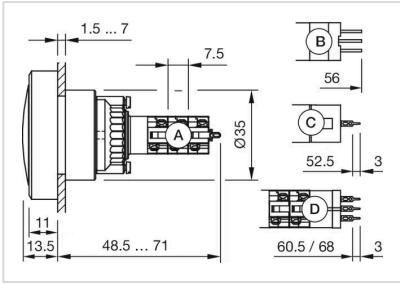

- A = Solder terminal
- B = Plug-in terminal 2.8 x 0.5 mm
- C = Universal terminal 2.0 mm x 0.5 mm
- D = Universal-Solder terminal