

Digital joystick

46-2F41.1080.000

Distribution by
Farnell



<https://farnell.eao.com/component/46-2F41.108...>

Your product:



46-2F41.1080.000 Digital joystick

Loading ...

MOUNTING

Design:	Raised
Mounting cut-out:	Ø 22.3 mm
Mounting type:	Panel mounting

OPERATING-/INDICATION PART

Lever colour:	Grey
Lever material:	plastic

ELECTRICAL CHARACTERISTICS

Pollution degree:	3
Protection class:	II, according to EN / IEC 61140

MECHANICAL CHARACTERISTICS

Switching action:	Maintained
Switching positions:	2 positions
Switching angle:	28°
Mechanical lifetime:	1 Mil. cycles of operation
Tightening torque:	2 ... 3 Nm (17.7 ... 26.6 Lb-in)
Weight:	0.04 kg

AMBIENT CONDITION

IP front protection:	IP66
-----------------------------	------

IK front protection: IK03

Operating temperature: - 40 °C ... + 70 °C

Shock resistance: 30g, 18ms (EN-IEC 60068-2-27)
50g, 11ms (EN-IEC 60068-2-27)

Vibration resistance: 5g f= 2...500Hz (EN-IEC 60068-2-6)

Climate resistance: +25°C-97%RH / +45°C-93%RH (IEC-EN60068-2-30)

CERTIFICATE

Approbations: CSA, UL

Conformities: CE

REACH: REACH compliant

RoHS: RoHS compliant

Standards: CEI EN 61373, CSA C22-2, IEC EN 60947-1, IEC EN 60947-5-1, UL508

OTHER

Short Description: Digital joystick, Ø 22.3 mm, Grey, Maintained, IP66, IK03

Dimension: 55 mm

Housing colour: Grey

Housing material: Plastic

Colour RAL: 7016 RAL

max. number of switching elements: 4

Component layouts:

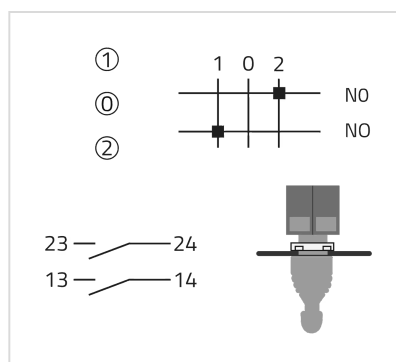

Mounting cut-outs:

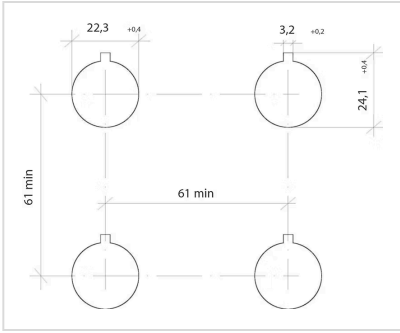

Dimension drawings:

