

# Actuator

51-  
148.025D2

Distribution by  
Farnell

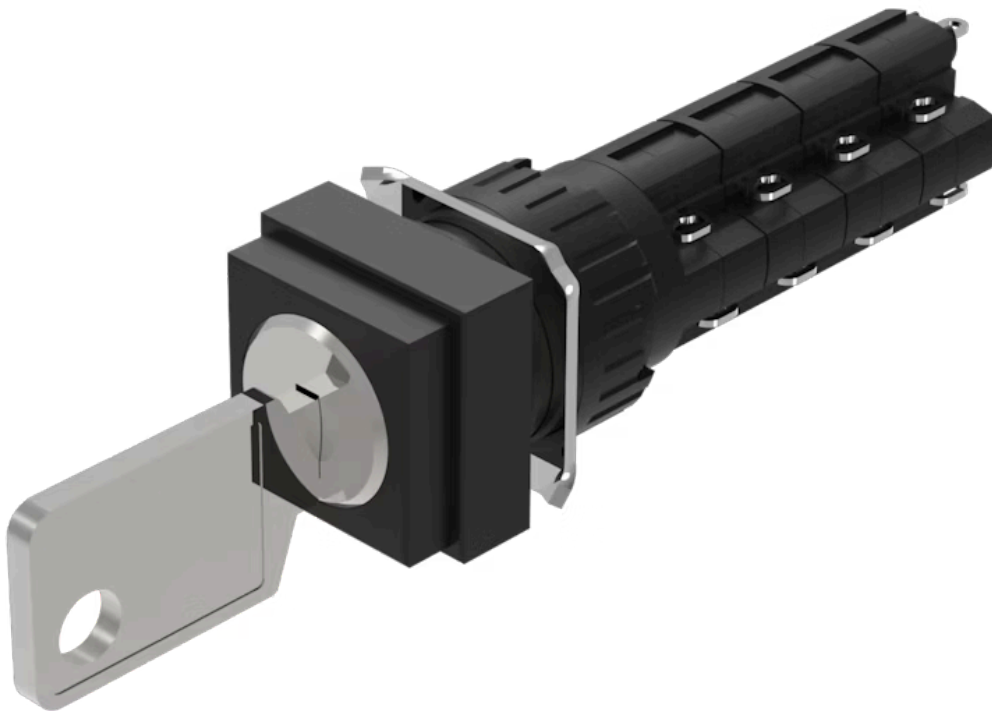

<https://farnell.eao.com/component/51-148.025D...>

Your product:

---



## 51-148.025D2 Actuator

### FRONT

<b>Front dimension:</b>	18 mm x 18 mm
<b>Front form:</b>	Square

### MOUNTING

<b>Design:</b>	Raised
<b>Mounting type:</b>	Panel mounting

### ELECTRICAL CHARACTERISTICS

<b>Switching voltage and switching current:</b>	250 VAC, 5 A (ohmic) 250 VAC, 3 A (Soldering terminal) 250 VAC, 2 A (inductive, $\cos(\phi) = 0.7$ ) 125 VAC, 3 A (inductive, $\cos(\phi) = 0.7$ ) 220 VDC, 0.1 A (inductive, L:R = 30 ms) 110 VDC, 0.2 A (inductive, L:R = 30 ms) 60 VDC, 0.7 A (inductive, L:R = 30 ms) 24 VDC, 2 A (inductive, L:R = 30 ms)
<b>Contacts:</b>	4 NC / 4 NO
<b>Rated Operational Voltage <math>U_e</math>:</b>	250 VAC/DC according to EN IEC 60947-1
<b>Switching rating:</b>	250 V @ 5 A
<b>Electrical lifetime:</b>	50 000 cycles of operation
<b>Electric strength:</b>	2500 VAC, 50 Hz, 1 min. between all terminals and earth, according to IEC 61058-1, part 15
<b>Protection class:</b>	II
<b>Standards:</b>	According to EN/IEC 61058-1
<b>Thermal current <math>I_{th}</math>:</b>	5 A, according to EN / IEC 60947-5-1 The maximum current in continuous operation and at ambient temperature not exceeding the quoted maximum values.

## MECHANICAL CHARACTERISTICS

<b>Terminal:</b>	Soldering terminal
<b>Contact material:</b>	Gold
<b>Switching action:</b>	Rest (a) - Momentary
<b>Switching system:</b>	Snap-action switching element
<b>Switching system:</b>	Self-cleaning, double-break snap action switching system, 1 normally closed and 1 normally open contact per element.
<b>Switching positions:</b>	2 positions
<b>Switching angle:</b>	42° right
<b>Mechanical lifetime:</b>	50 000 cycles of operation
<b>Operating force:</b>	1,8 ... 6 N, depending on the number of switching elements
<b>Tightening torque:</b>	Fixing nut max. 0.5 Nm
<b>Wire cross section:</b>	Snap-action switching element with tinned soldering terminals at the sides Max. wire diameter 2 wires à 1.2 mm Max. wire cross-section of stranded cable 1 x 1 mm <sup>2</sup>
<b>Weight:</b>	0.023 kg

## AMBIENT CONDITION

<b>IP front protection:</b>	IP65, according to DIN EN 60529
<b>Operating temperature:</b>	- 25 °C ... + 55 °C
<b>Storage temperature:</b>	- 40 °C ... + 85 °C
<b>Shock resistance:</b>	15 g for 11 ms, as per DIN / EN 60512-4-3, DIN / EN 60068-2-27 (Single impacts, semi-sinusoidal)
<b>Vibration resistance:</b>	10 g at 10 Hz...1500 Hz, amplitude 0.75 mm (Sinusoidal), according to DIN EN 60512-4-4, DIN EN 60068-2-6
<b>Climate resistance:</b>	Standard condition, as per DIN EN 60068-2-30 Changing condition, as per DIN EN 60068-2-14

## CERTIFICATE

<b>Approbations:</b>	CB (IEC 61058-1), CQC, CSA, DNV, ENEC (EN 61058-1), UL
<b>Conformities:</b>	CE, UKCA, 2011 / 65 / EC (RoHS), 2014 / 30 / EU (EMC), 2014 / 35 / EU (LVD)
<b>REACH:</b>	REACH compliant
<b>RoHS:</b>	RoHS compliant

## OTHER

**Short Description:**

Actuator, 18 mm x 18 mm, Square, 4 NC / 4 NO, Rest (a) - Momentary, Soldering terminal, IP65, according to DIN EN 60529

**Housing colour:**

Black

**Hints:**

Standard lock: DOM 311

**max. number of switching elements:**

4

**Switching positions:**

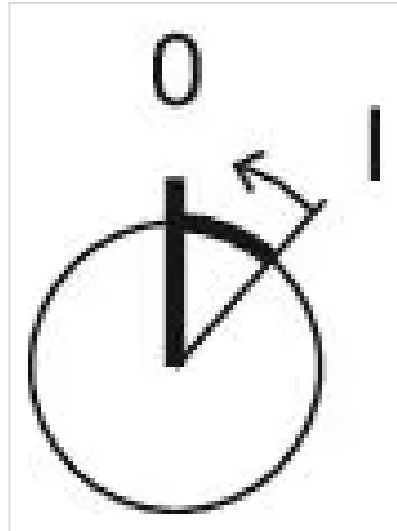

**Wiring diagrams:**

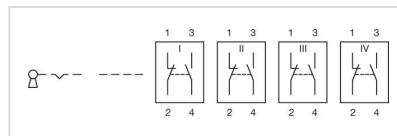

**Mounting cut-outs:**

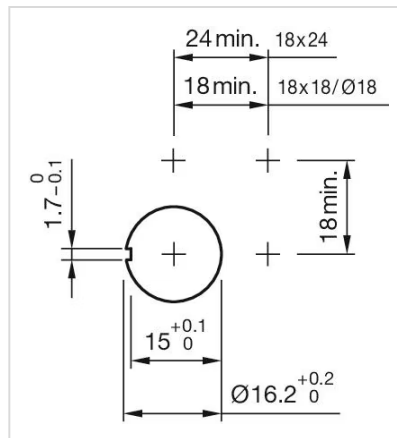

**Dimension drawings:**



- A = Solder terminal
- B = Plug-in terminal 2.8 mm x 0.5 mm
- C = Universal terminal 2.0 mm x 0.5 mm