

# Actuator

51-  
256.0268

Distribution by  
Farnell

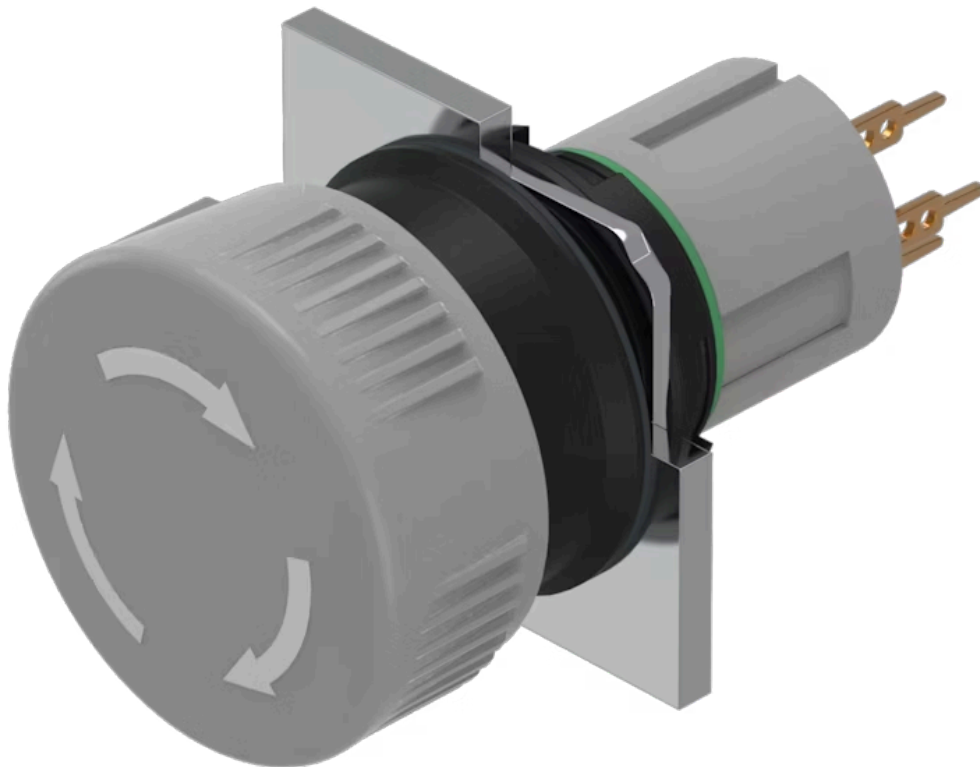

<https://farnell.eao.com/component/51-256.0268...>

Your product:

---



## 51-256.0268 Actuator

### FRONT

**Front dimension:** Ø 24,5 mm

**Front form:** Round

### MOUNTING

**Design:** Raised

**Mounting type:** Panel mounting

### OPERATING-/INDICATION PART

**Lens colour:** Grey

**Lens material:** Plastic

**Lens illumination:** Non illuminated

**Lens shape:** Mushroom-head

**Lens optics:** opaque

### ELECTRICAL CHARACTERISTICS

**Switching voltage and switching current:** 100 mA at 42 VAC/VDC

**Contacts:** 1 NC

**Switching rating:** 42 V AC @ 0,1 A

### MECHANICAL CHARACTERISTICS

**Terminal:** Universal terminal, 2 x 0.5 mm

**Contact material:** Gold

<b>Switching action:</b>	Maintained
<b>Switching system:</b>	Low-level element
<b>Switching system:</b>	This low-level switching element was designed for switching low powers in electronic circuits. The mechanism assures reliable switching of loads ranging from a few $\mu\text{A}/\mu\text{V}$ up to 100 mA/ 42 VAC/DC. Single-break momentary contact, as normally open or normally closed with 4 independent points of contact. 2 momentary contacts per switching element; combination of normally open and normally closed is possible. Special features are the long life, extremely short rebound time and stable contact resistance.
<b>Release type:</b>	Twist to unlock
<b>Mechanical lifetime:</b>	1 Mil. cycles of operation (RCC/RPB)
<b>Operating force:</b>	18 ... 21 N (depending on the switching element)
<b>Operating Travel:</b>	3 mm
<b>Tightening torque:</b>	Fixing nut max. 0.5 Nm
<b>Terminal details 1:</b>	The universal terminals permit these units to be mounted on printed circuit boards (PCB). These terminals can also be used as soldering or plug-in terminals. For these terminals we can also supply a plug-in base which, when soldered on to the board, enables the switch to be plugged in.
<b>Weight:</b>	0.014 kg

## AMBIENT CONDITION

<b>IP front protection:</b>	IP65, according to DIN EN 60529
<b>Operating temperature:</b>	- 25 °C ... + 55 °C
<b>Storage temperature:</b>	- 40 °C ... + 85 °C

## CERTIFICATE

<b>REACH:</b>	REACH compliant
<b>RoHS:</b>	RoHS compliant

## OTHER

<b>Short Description:</b>	Actuator, $\varnothing$ 24,5 mm, Mushroom-head, Non illuminated, Grey, Plastic, opaque, Round, 1 NC, Maintained, Universal terminal, 2 x 0.5 mm, IP65, according to DIN EN 60529, Twist to unlock
<b>Housing colour:</b>	Black
<b>Hints:</b>	Marking arrows
<b>Wiring diagrams:</b>	

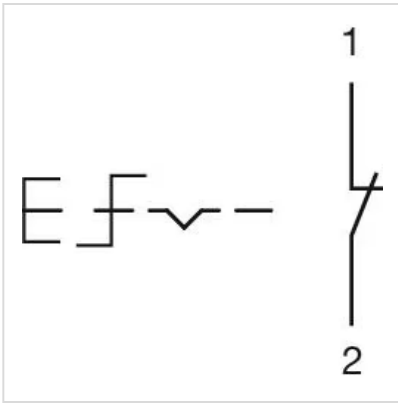

**Mounting cut-outs:**

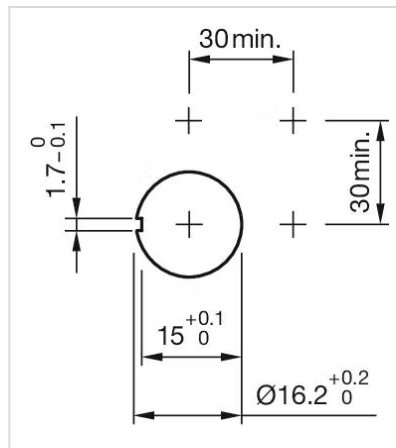

**Dimension drawings:**

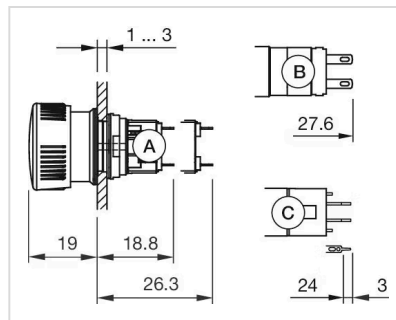

- A = Solder terminal
- B = Plug-in terminal 2.8 mm x 0.5 mm
- C = Universal terminal 2.0 mm x 0.5 mm