

Actuator

52-
271.022

Distribution by
Farnell



<https://farnell.eao.com/component/52-271.022/...>

Your product:



52-271.022 Actuator

Loading ...

MOUNTING

Mounting type: Panel mounting

OPERATING-/INDICATION PART

Lever material: plastic

Lever shape: short

ELECTRICAL CHARACTERISTICS

Switching voltage and switching current:
250 VAC, 5 A (ohmic)
250 VAC, 3 A (Soldering terminal)
250 VAC, 2 A (inductive, $\cos(\phi) = 0.7$)
125 VAC, 3 A (inductive, $\cos(\phi) = 0.7$)
220 VDC, 0.1 A (inductive, L:R = 30 ms)
110 VDC, 0.2 A (inductive, L:R = 30 ms)
60 VDC, 0.7 A (inductive, L:R = 30 ms)
24 VDC, 2 A (inductive, L:R = 30 ms)

Contacts: 1 NC / 1 NO

Rated Operational Voltage U_e : 250 VAC/DC according to EN IEC 60947-1

Switching rating: 250 V @ 5 A

Electric strength: 2500 VAC, 50 Hz, 1 min. between all terminals and earth, according to IEC 61058-1, part 15

Protection class: II

Standards: According to EN/IEC 61058-1

Thermal current I_{th} : 5 A, according to EN / IEC 60947-5-1
The maximum current in continuous operation and at ambient temperature not exceeding the quoted maximum values.

MECHANICAL CHARACTERISTICS

Terminal: Plug-in terminal, 2.8 x 0.5 mm

Contact material:	Gold
Switching action:	Rest - Maintained
Switching system:	Snap-action switching element
Switching system:	Self-cleaning, double-break snap action switching system, 1 normally closed and 1 normally open contact per element.
Switching positions:	2 positions
Switching angle:	90° right
Mechanical lifetime:	1 Mil. cycles of operation
Operating force:	1,8 ... 6 N, depending on the number of switching elements
Tightening torque:	Fixing nut max. 0.5 Nm
Wire cross section:	Snap-action switching element with axial soldering terminals, which can also be used as plug-in terminals 2.8 x 0.5mm Max. wire diameter 2 wires of 1 mm Max. wire cross-section of stranded cable 2 of 0.75 mm ² or 1 x 1.0 mm ²
Weight:	0.008 kg

AMBIENT CONDITION

IP front protection:	IP65, according to DIN EN 60529
Operating temperature:	- 25 °C ... + 55 °C
Storage temperature:	- 40 °C ... + 85 °C
Shock resistance:	15 g for 11 ms, as per DIN / EN 60512-4-3, DIN / EN 60068-2-27 (Single impacts, semi-sinusoidal)
Vibration resistance:	10 g at 10 Hz...1500 Hz, amplitude 0.75 mm (Sinusoidal), according to DIN EN 60512-4-4, DIN EN 60068-2-6
Climate resistance:	Standard condition, as per DIN EN 60068-2-30 Changing condition, as per DIN EN 60068-2-14

CERTIFICATE

Approbations:	CB (IEC 61058-1), CQC, CSA, DNV, ENEC (EN 61058-1), UL
Conformities:	CE, UKCA, 2011 / 65 / EC (RoHS), 2014 / 30 / EU (EMC), 2014 / 35 / EU (LVD)
REACH:	REACH compliant
RoHS:	RoHS compliant

OTHER

Short Description:	Actuator, optional illuminative, short, 1 NC / 1 NO, Rest - Maintained, Plug-in terminal, 2.8 x 0.5 mm, IP65, according to DIN EN 60529
---------------------------	---

Housing colour:

Black

Hints:

Illuminative

Switching positions:

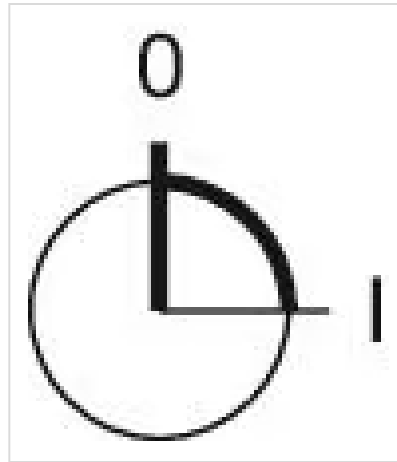

Wiring diagrams:

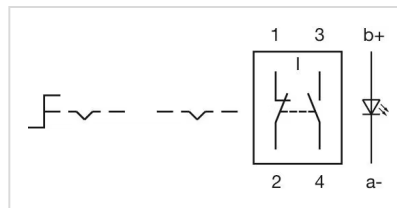

Mounting cut-outs:

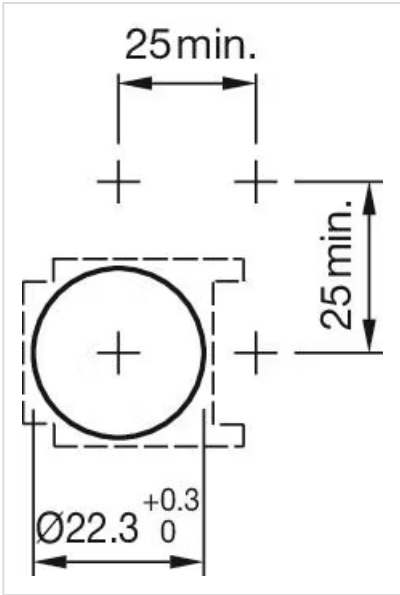
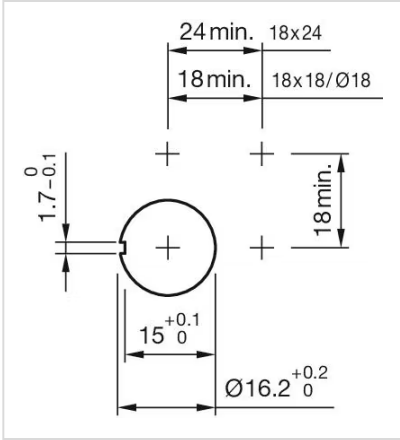
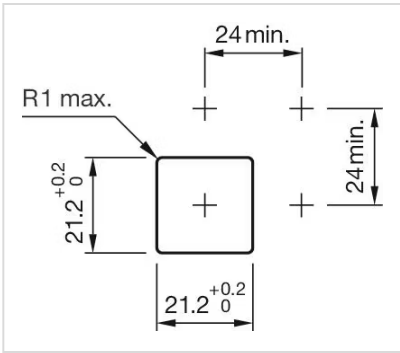

Dimension drawings:

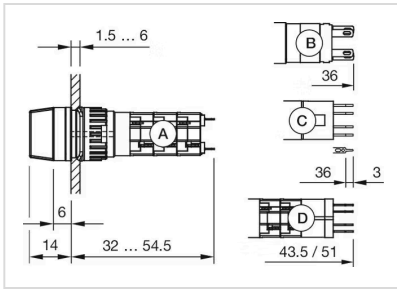

- A = Solder terminal
- B = Plug-in terminal 2.8 mm x 0.5 mm
- C = Universal terminal 2.0 mm x 0.5 mm
- D = Universal-Solder terminal

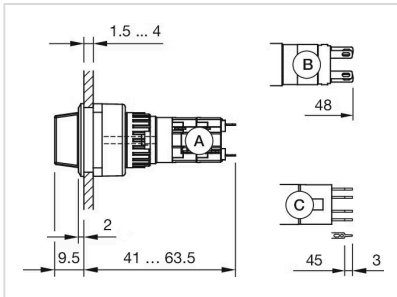

- A = Solder terminal
- B = Solder terminal 2.8 mm x 0.5 mm
- C = Universal terminal 2.0 mm x 0.5 mm