

Blind plug

704.964.8

Distribution by
Farnell



<https://farnell.eao.com/component/704.964.8/e...>

Your product:



704.964.8 Blind plug

Loading ...

FRONT

Colour: Black

MOUNTING

Mounting cut-out: Ø 30.5 mm

ELECTRICAL CHARACTERISTICS

Forward voltage:

MECHANICAL CHARACTERISTICS

Weight: 0.008 kg

OTHER

Short Description: Blind plug, Ø 36 mm, Ø 30.5 mm, Plastic, Black

Titel Accessory: Blind plug

Dimension: Ø 36 mm

Material: Plastic

Hints: Please note that bigger minimum distances are necessary

Dimension drawings:

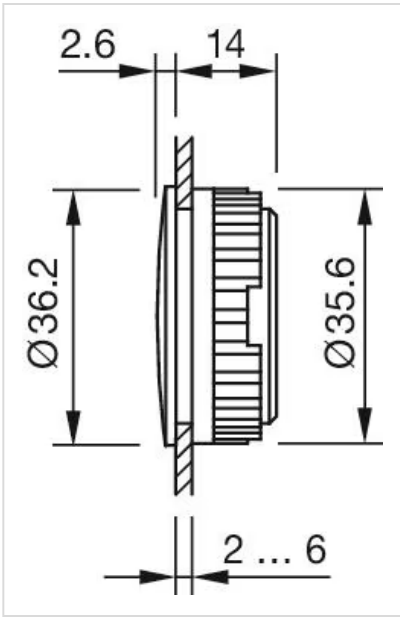

for Part No. 704.964.8